



katalog náhradních dílů
automatického kotle
KP 11

PONAST spol. s r.o
Na Potůčkách 163
757 01 Valašské Meziříčí
ČESKÁ REPUBLIKA
tel.: 571 688111*
e-mail: ponast@ponast.cz

aktualizace: 07/12/2018



Kotel KP11

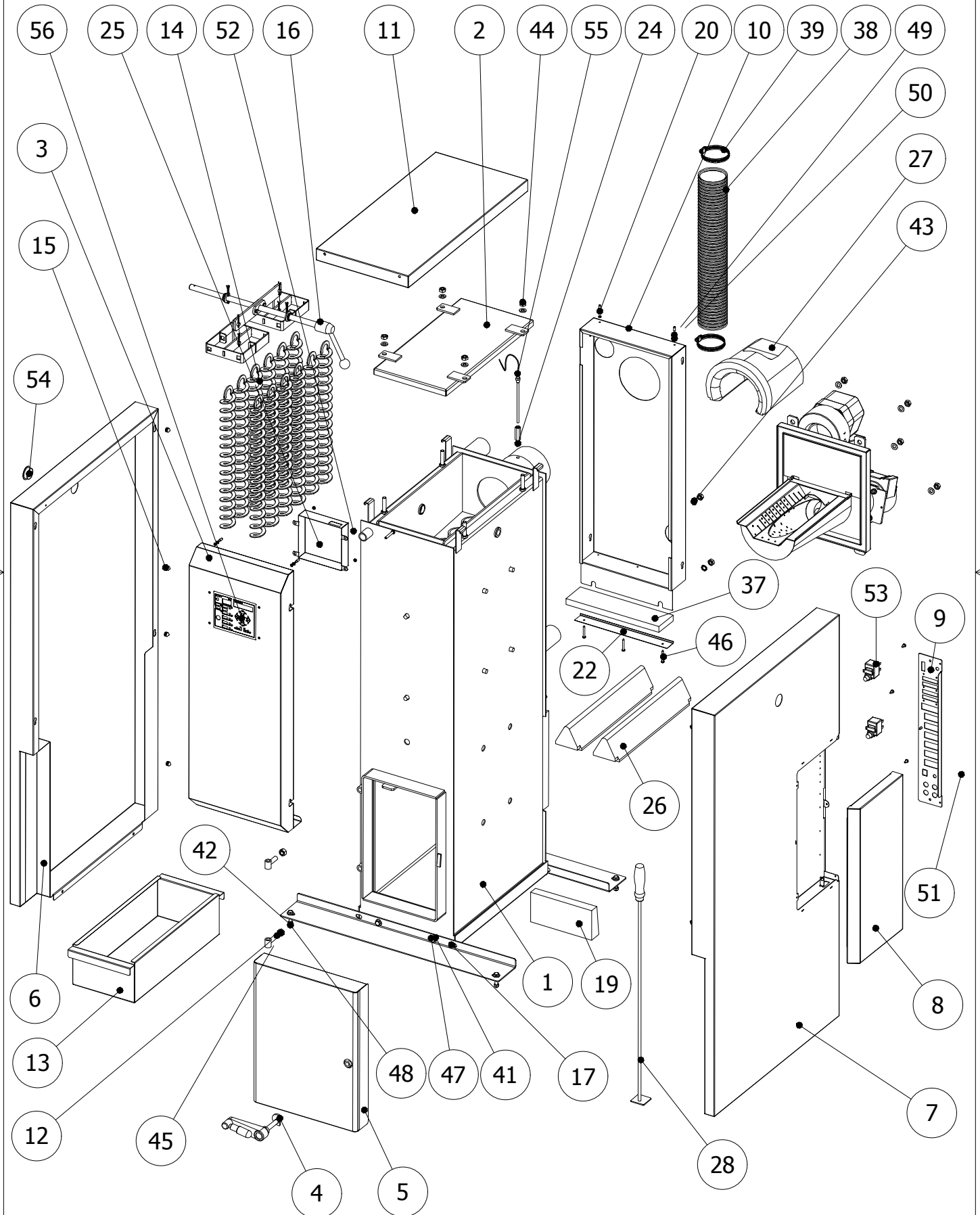

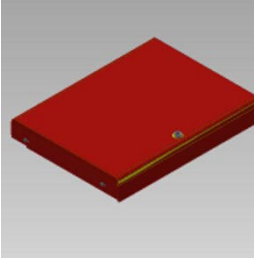



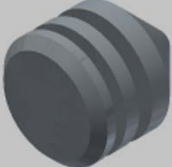



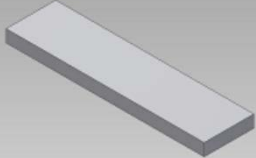
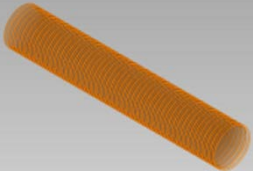

KOTEL KP11	POZICE	POPIS	KÓD	ČÍSLO SOUČÁSTI	POČET KS	POZNÁMKY
	1	TĚLESO KOTLOVÉ	PKXX1101	056.S01.000.A1	1	Sestava
	2	VÍKO	KKTX0002	002.S02.000.A2	1	Sestava
	3	KRYT PŘEDNÍ	PKMD0191	763.S03.000.A3	1	
	4	KLIKA x2	KKTX0019	338.S04.000.A3	1	Sestava
	5	DVÍŘKA KP11	KKTX0015	056.S05.000.A2	1	Sestava
	6	BOČNICE LEVÁ	PKMBB0188 PKMBB0248	756.S01.001.A3 756.S01.000.A3	1	PRAVÝ LEVÝ





KOTEL KP11	POZICE	POPIS	KÓD	ČÍSLO SOUČÁSTI	POČET KS	POZNÁMKY
	7	BOČNICE PRAVÁ	PKMBB0189 PKMBB0247	756.S02.000.A3	1	PRAVÝ LEVÝ
	8	KRYT JEDNOTKY BOČNÍ	PKMBB0142	726.008.000.A3	1	
	9	DESKA	PKMD0293 PKMD0293L	756.005.000.A4	1	PRAVÝ LEVÝ
	10	KRYT ZADNÍ	PKMBB0203	763.010.000.A2	1	
	11	KRYT HORNÍ	PKMD0204	763.011.000.A3	1	
	12	PANT DVÍŘEK	PKTX0121	054.S05.S03.A4	2	

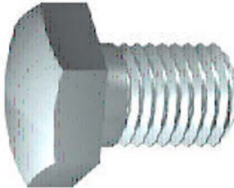
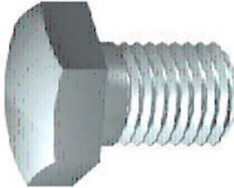

KOTEL KP11	POZICE	POPIS	KÓD	ČÍSLO SOUČÁSTI	POČET KS	POZNÁMKY
	13	POPELNÍK	KKTX0006	002.013.000.A3	1	
	14	TURBULÁTOR PLOCHÝ 460mm	MRUZ0016	054.016.000.A4	12	
	15	KLÍČ	PKRX0008	286.000.000.A4	8	
	16	ČISTĚNÍ VÝMĚNÍKU KP11	KKTX0054	760.000.000.A3	1	Sestava
	17	DRŽÁK KOTLE	PKRX0006	005.017.000.A3	2	
	19	KERAMIKA NAD DVÍŘKA KP11	MTKE0005	056.021.000.A4	1	

KOTEL KP11	POZICE	POPIS	KÓD	ČÍSLO SOUČÁSTI	POČET KS	POZNÁMKY
	20	DISTANCE	PKMX0037	054.009.003.A4	4	
	22	DRŽÁK SIBRALU	PKMD0088	374.055.000.A4	1	
	23	Hořák KP 10 TRANS MK04	KHXX1010	975.000.000.A3	1	Sestava
	24	REDUKCE	PKRX0004	001.048.000.A4	1	
	25	KRYT	PKMX0201	759.002.000.A3	1	
	26	KERAMIKA TROJÚHELNÍKOVÁ	MTKE0135	420.900.000.A3	2	

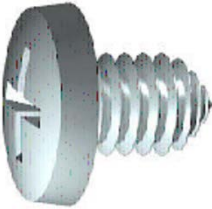
KOTEL KP11	POZICE	POPIS	KÓD	ČÍSLO SOUČÁSTI	POČET KS	POZNÁMKY
	27	REFLEKTOR KERAMICKÝ	MTKE0020	001.042.000.A3	1	
	28	ŠKRABKA	PKRX0001	001.S32.000.A4	1	
	37	SIBREX 300 20x80x319	MTIZ0020		1	
	38	HADICE FLEXADUR PU-1NO DN 80x1000	MRUZ0018		1	
	39	SPONA HADICOVÁ 70-90 NEREZ	MRUZ0089		2	
	40	VENTIL VYPOŠTĚCÍ S PÁČKOU	MRUZ0024		1	

KOTEL KP11	POZICE	POPIS	KÓD	ČÍSLO SOUČÁSTI	POČET KS	POZNÁMKY
	41	Podložka - A 10,5	MSPX0005	DIN 125	16	
	42	Šestihranná matice - M8	MSMX0021	DIN 934	4	Zn
	43	Zubová pojistná podložka - A 10,5	MSPX0003	DIN 6797	2	
	44	Šestihranná matice - M10	MSMX0002	DIN 934	10	
	45	Šestihranná matice - M12	MSMX0007	DIN 934	2	
	46	Šroub do plechu - ST4,8 x 13 - C - H	MSSX0118	ISO 7049	3	

KOTEL KP11	POZICE	POPIS	KÓD	ČÍSLO SOUČÁSTI	POČET KS	POZNÁMKY
	47	Šestihranný šroub - M8 x 20	MSSX0002	DIN 933	4	Zn
	48	Šestihranný šroub - M8 x 40	MSSX0027	DIN 933	4	
	49	Zubová pojistná podložka - A 4,3	MSPX0010	DIN 6797	4	
	50	Šestihranná matice - M4	MSMX0012	DIN 934	4	
	51	Šroub do plechu - ST4,8 x 38 - C - H	MSSX0042	ISO 7049	5	
	52	Šestihranná matice - M5	MSMX0017	DIN 934	4	

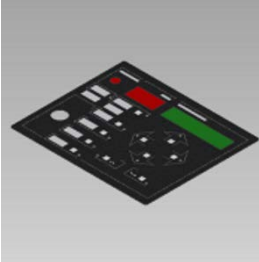
KOTEL KP11	POZICE	POPIS	KÓD	ČÍSLO SOUČÁSTI	POČET KS	POZNÁMKY
	53	HAVARIJNÍ TERMOSTAT LY 26 I	METRO049		2	
	54	ZÁSLEPKA ČERNÁ 35-38mm	MRUZ0228		1	
	55	ČIDLO KOMÍNOVÉ RJE	PKRX0060		1	
	56	KLÁVESNICE KP X1	METRO116		1	

TĚLESO KOTLOVÉ KP11

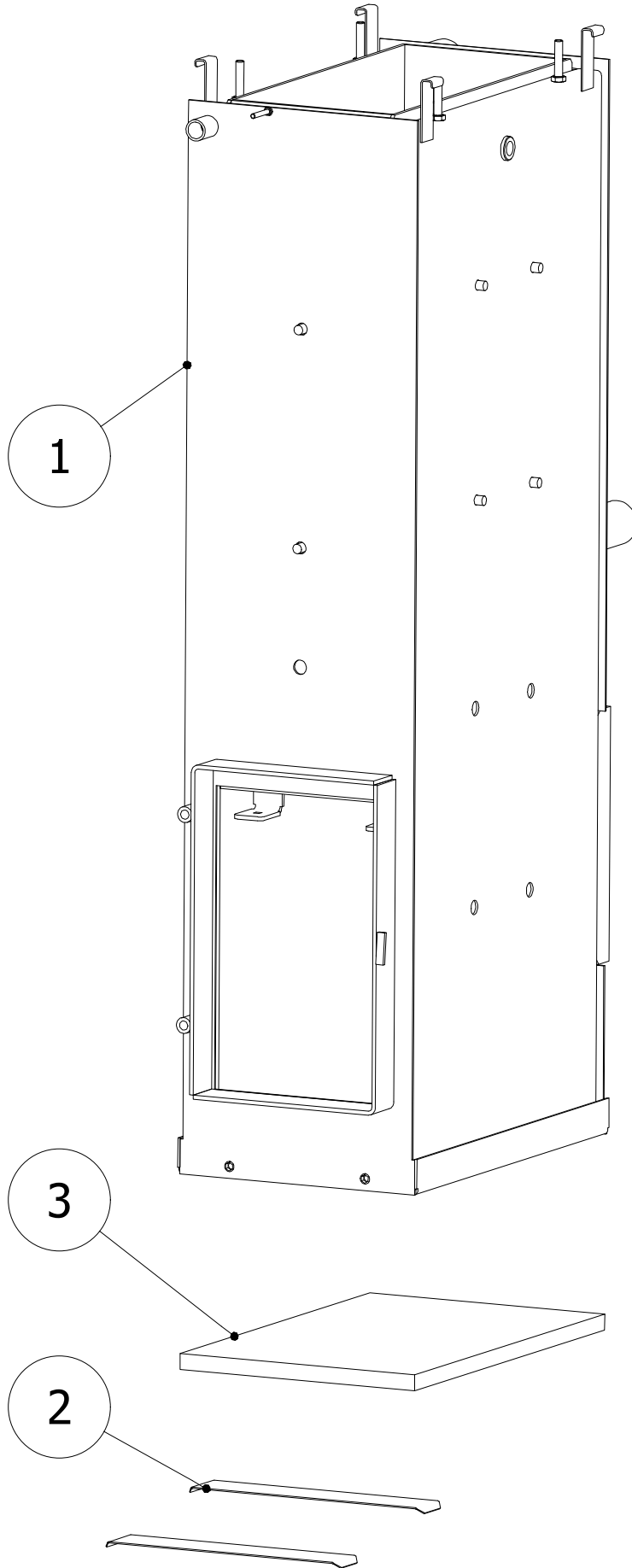

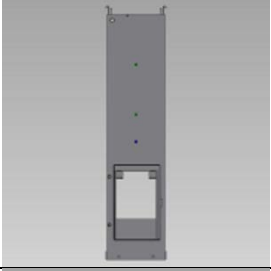
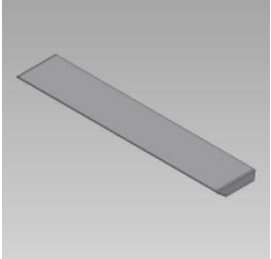
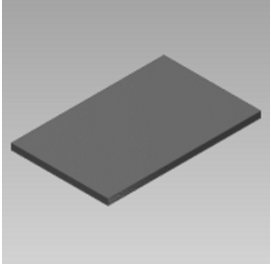
TĚLESO KOTLOVÉ KP11	POZICE	POPIS	KÓD	ČÍSLO SOUČÁSTI	POČET KS	POZNÁMKY
	1	TĚLESO KOTLOVÉ	PKXX1101	056.S01.000.A1	1	
	2	DRŽÁK IZOLACE KP11,KP12	PKTX0346	PKTX0346	2	
	3	IZOLACE 20x515x327	PKTX0342		1	

VÍKO

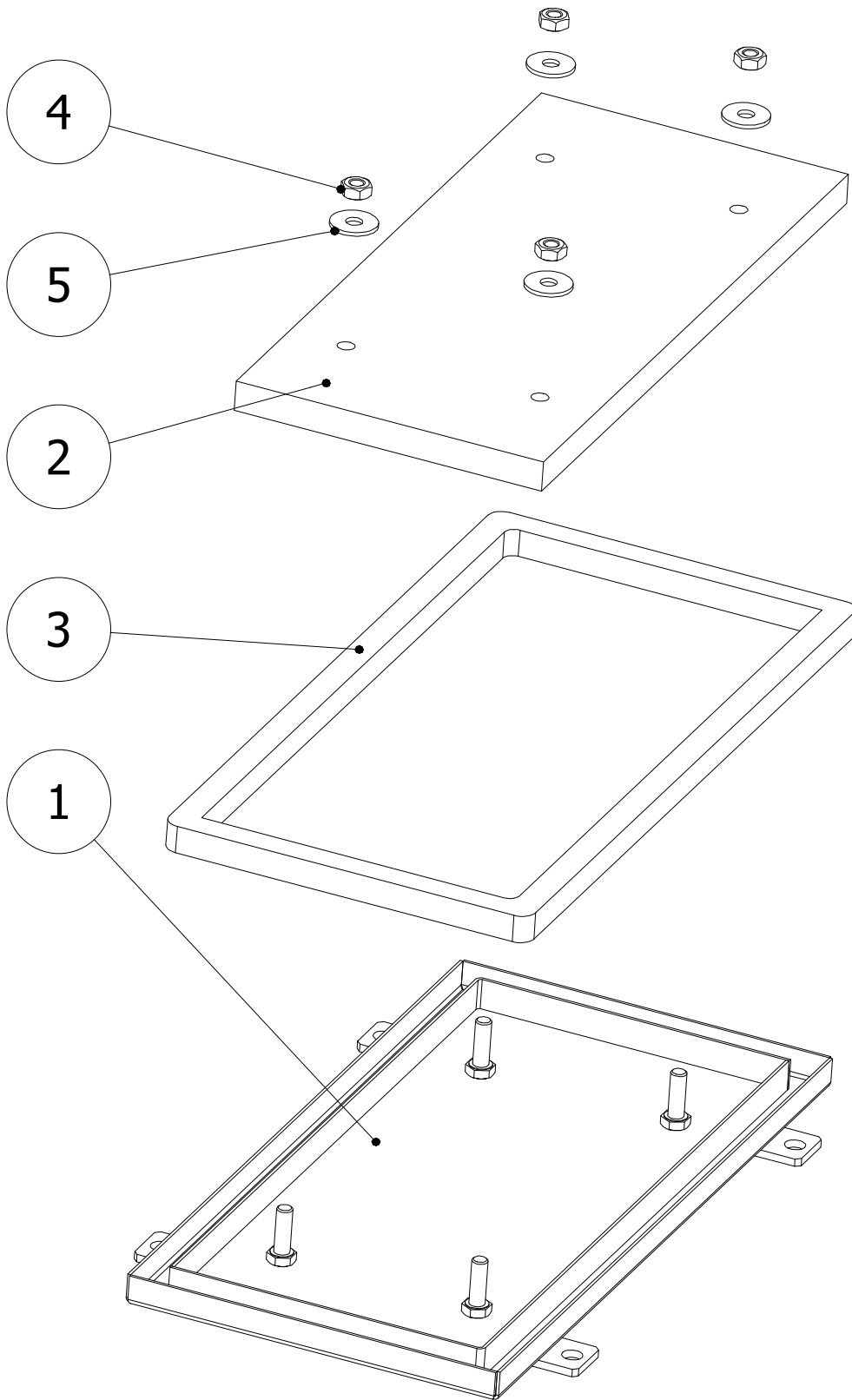

VÍKO	POZICE	POPIS	KÓD	ČÍSLO SOUČÁSTI	POČET KS	POZNÁMKY
	1	VÍKO KOTL.TĚLES A KP10,11	PKTX0026	002.002.000.A2	1	
	2	SIBREX 140 20x208x446	MTIZ0006		1	
	3	ŠŇŮRA TĚSNÍCÍ 18x18	MRUZ0133		1.4m	
	4	Šestihránná matice - M10	MSMX000 2	DIN 934	4	Zn
	5	Podložka - 10,5	MSPX0004	DIN 9021	4	Zn

KLIKA

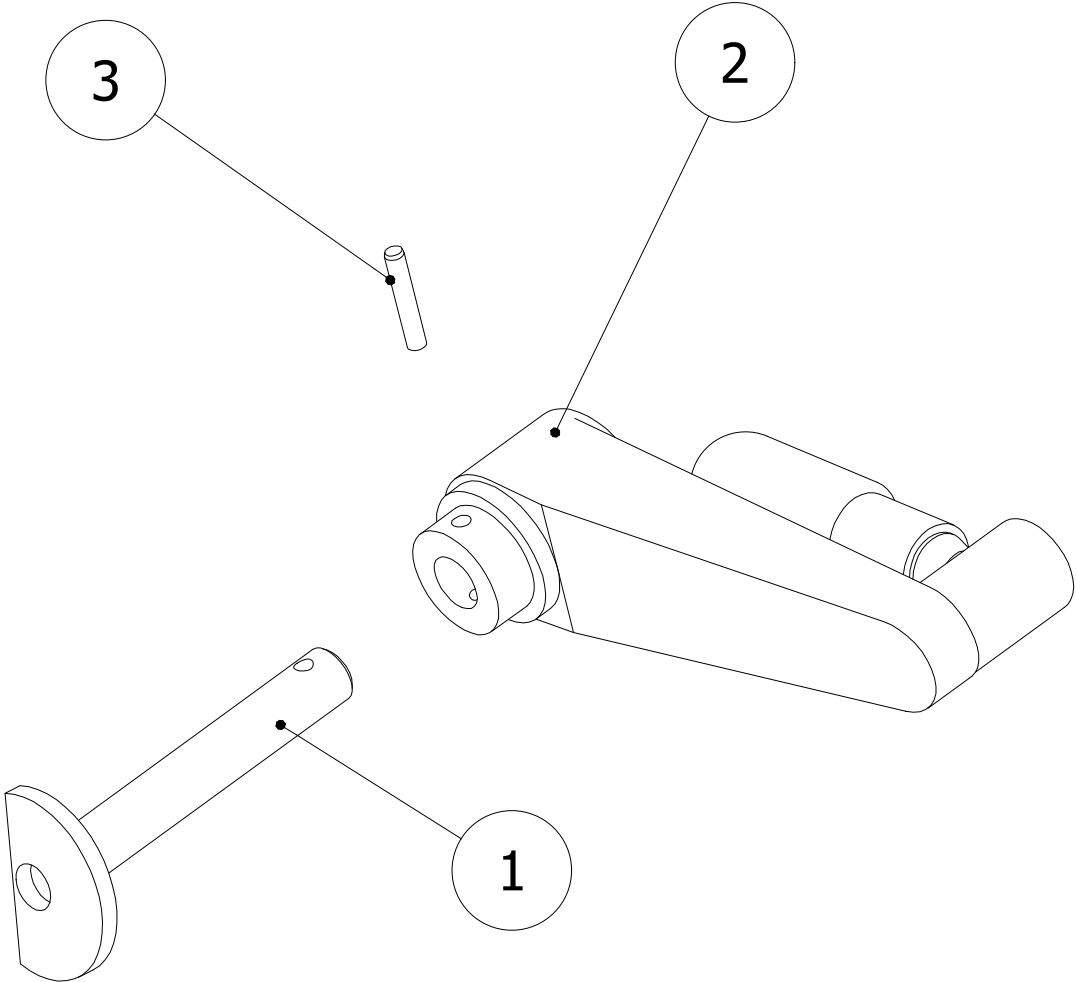

KLIKA	POZICE	POPIS	KÓD	ČÍSLO SOUČÁSTI	POČET KS	POZNÁMKY
	1	DŘÍK KLIKY	PKTX0118	054.S04.001.A3	1	
	2	KLIKA SKLAPOVACÍ ELESA GANTER	MRUZ0117	MT.100-AT+IR	1	KÓD 44317
	3	Kolík - 4 x 24 - A (kalený)	MSRX0003	ISO 8734	1	

DVÍŘKA

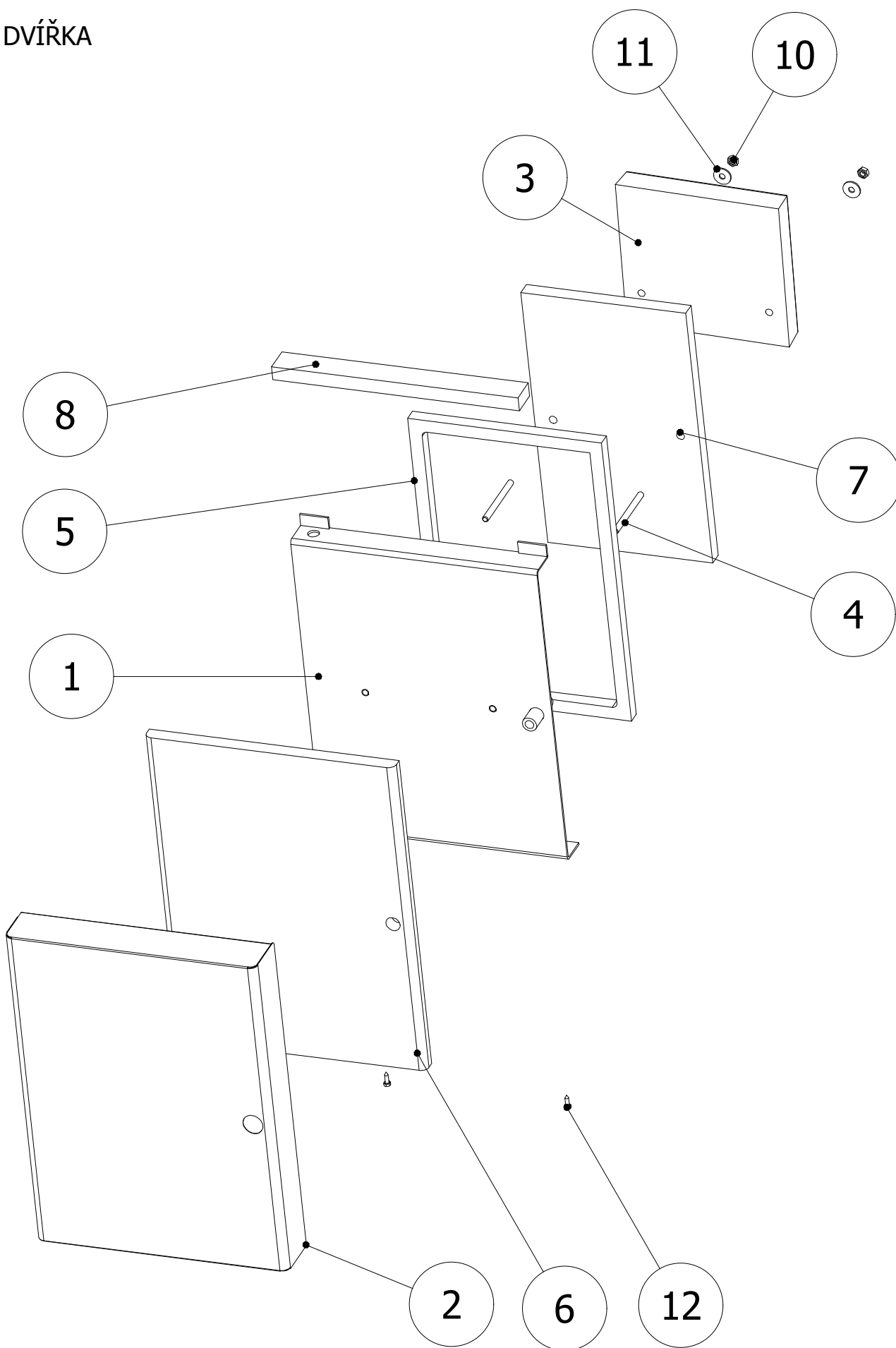

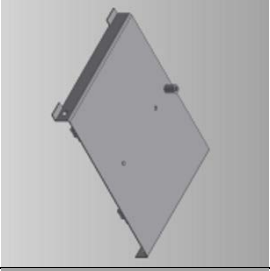
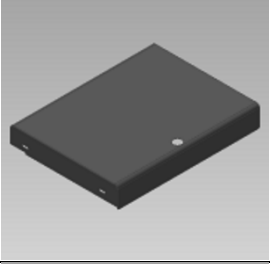
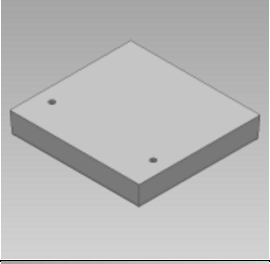
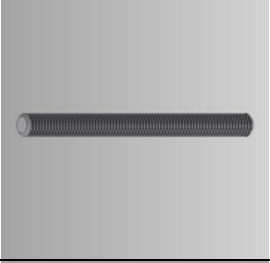
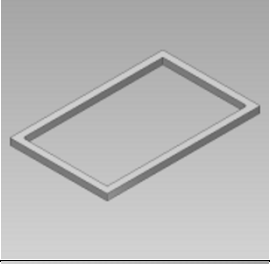
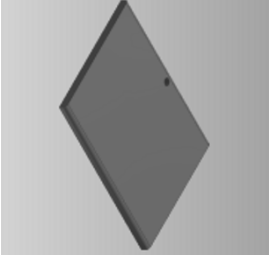

DVÍŘKA	POZICE	POPIS	KÓD	ČÍSLO SOUČÁSTI	POČET KS	POZNÁMKY
	1	DVÍŘKA KP11	PKTX0120	056.005.000.A3	1	
	2	KRYT DVÍŘEK	PKMD0043	056.012.000.A3	1	
	3	KERAMIKA NA DVÍŘKA KP11	MTKE0007	056.005.008.A4	1	
	4	TYČ ZÁVITOVÁ M8x95	PKTX0117		2	
	5	ŠŤŮRA TĚSNÍCÍ 18x18	MRUZ0133		1.35m	
	6	IZOLACE DVÍŘEK KP11 20x353x469	MTIZ0011		1	

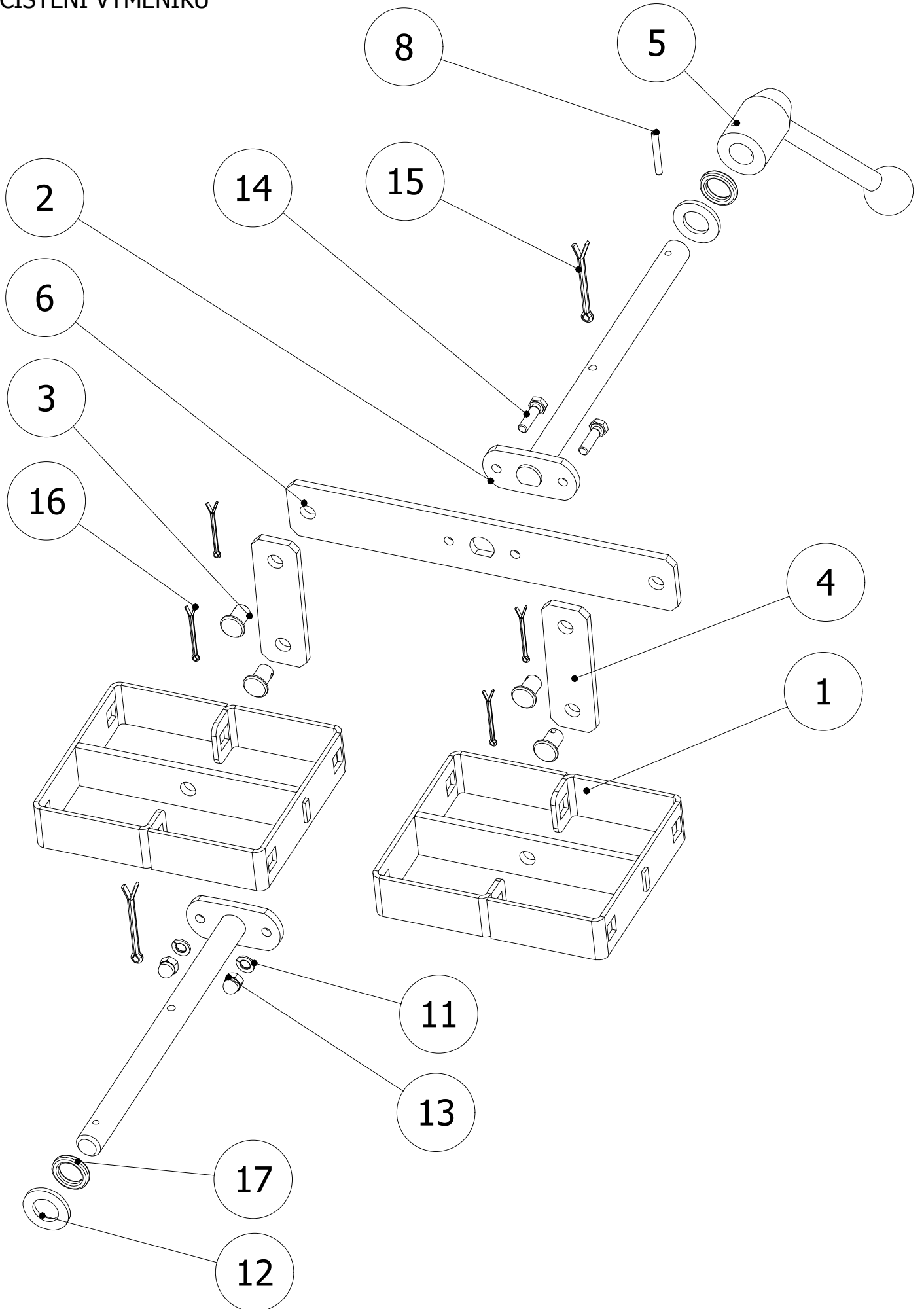

DVÍŘKA	POZICE	POPIS	KÓD	ČÍSLO SOUČÁSTI	POČET KS	POZNÁMKY
	7	IZOLACE TĚLA 20x387x233	MTIZ0004		1	
	8	IZOLACE DVÍŘEK KP11 20x38x348	MTIZ0011		1	
	10	Šestihranná matice - M8	MSMX0016	DIN 934	2	Zn
	11	Podložka - 8,4	MSPX0008	DIN 9021	2	Zn
	12	Šroub samořezný se 6hr. hl. - ST 4,8 x 16	MSSX0017	ISO 1479	2	

ČISTĚNÍ VÝMĚNÍKU



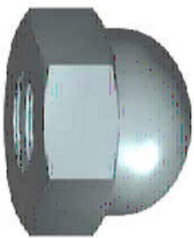
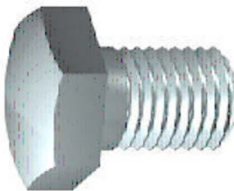
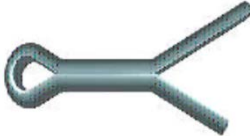

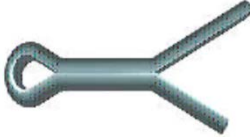
ČISTĚNÍ VÝMĚNÍKU	POZICE	POPIS	KÓD	ČÍSLO SOUČÁSTI	POČET KS	POZNÁMKY
	1	VAHADLO	PKTX0330	760.S01.000.A4	2	
	2	NÁSTAVEC	PKTX0332	760.S06.S00.A4	2	
	3	ČEP	PKTX0053	005.S16.007.A4	4	
	4	ZÁVĚS	PKTX0051	005.S16.004.A4	2	
	5	PÁKA UPÍNACÍ	MRUZ0222	GN 212-32-B16-C	1	
	6	TÁHLO 2	PKTX0359	758.S06.A02.A4	1	

ČISTĚNÍ VÝMĚNÍKU	POZICE	POPIS	KÓD	ČÍSLO SOUČÁSTI	POČET KS	POZNÁMKY
	8	Pružné přímé kolíky 4 x 30	MSRX0090	ISO 8752	1	
	11	Pružná podložka - A6	MSPX0019	DIN 128	2	
	12	Ploché podložky - 16	MSPX0030	ISO 7089	2	
	13	Šestihranná matice uzavřená - M6	MSMX002 7	DIN 1587	2	
	14	Šestihranný šroub - M6 x 22	MSSX0225	DIN 933	2	
	15	Závlačka - 4 x 50	MSRX0021	ISO 1234	2	

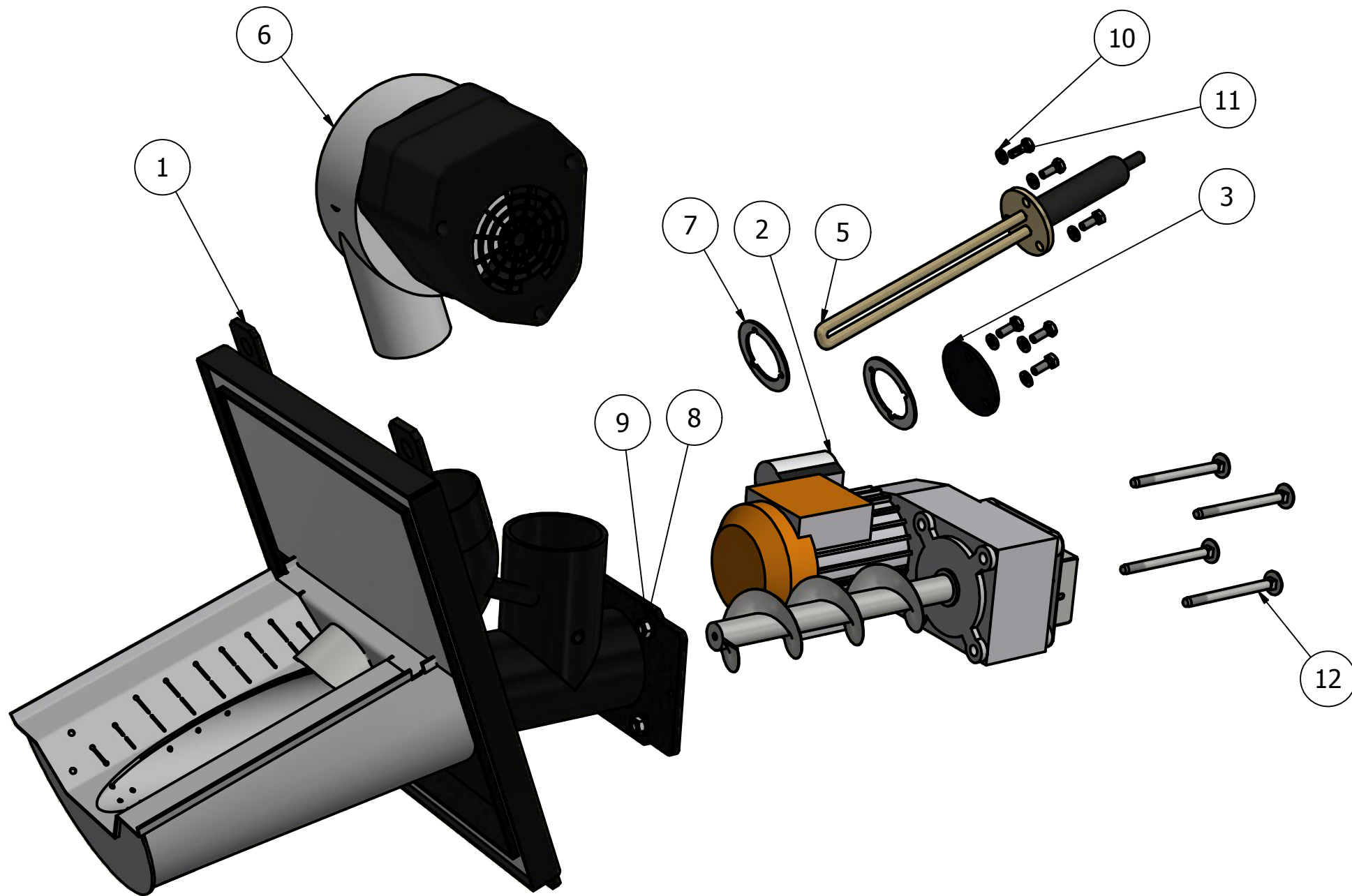
ČISTĚNÍ VÝMĚNÍKU	POZICE	POPIS	KÓD	ČÍSLO SOUČÁSTI	POČET KS	POZNÁMKY
	16	Závlačka - 2,5 x 36	MSRX0048	ISO 1234	4	
	17	Šňůra těs. čistění 4x4	PKTX0432		2	

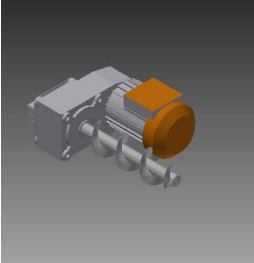
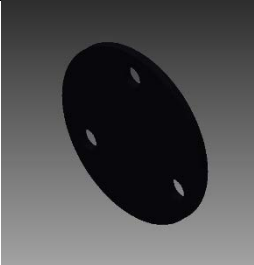

Hořák KP 10 TRANS MK04

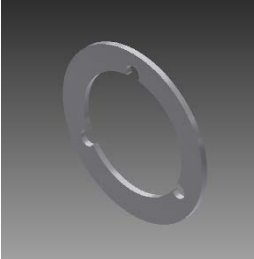
Hořák KP 10 TRANS MK04	POZICE	POPIS	KÓD	ČÍSLO SOUČÁSTI	POZICE KS	POZNÁMKY
	1	Hořák KP 10 svař+těs+sib	KHXX1002	099.001.000.A3	1	
	2	Podavač P2 TRANS_MK04+CA N.	KHXX1009	973.S03.000.A3	1	
	3	VÍČKO	PHXX0113	116.018.000.A4	1	
	5	Spirála zapalovací 500W	MERX0011	Spirála 500W	1	
	6	VENTILÁTOR RLG 97	MEVE0005		1	
	7	TĚSNĚNÍ	PHXX0115	493.021.000.A4	2	

Hořák KP 10 TRANS MK04	POZICE	POPIS	KÓD	ČÍSLO SOUČÁSTI	POZICE KS	POZNÁMKY
	8	Šestihránná matice - M8	MSMX0016	DIN 934	4	Zn
	9	Podložka - A 8,4	MSPX0001	DIN 125	4	Zn
	10	Podložka - A 6,4	MSPX0026	DIN 125	6	Zn
	11	Šestihránný šroub - M6 x 16	MSSX0015	DIN 933	6	
	12	Šroub s půlk.hl.a 4rh.krčkem - M8 x 100	MSSX0129	DIN 603	4	

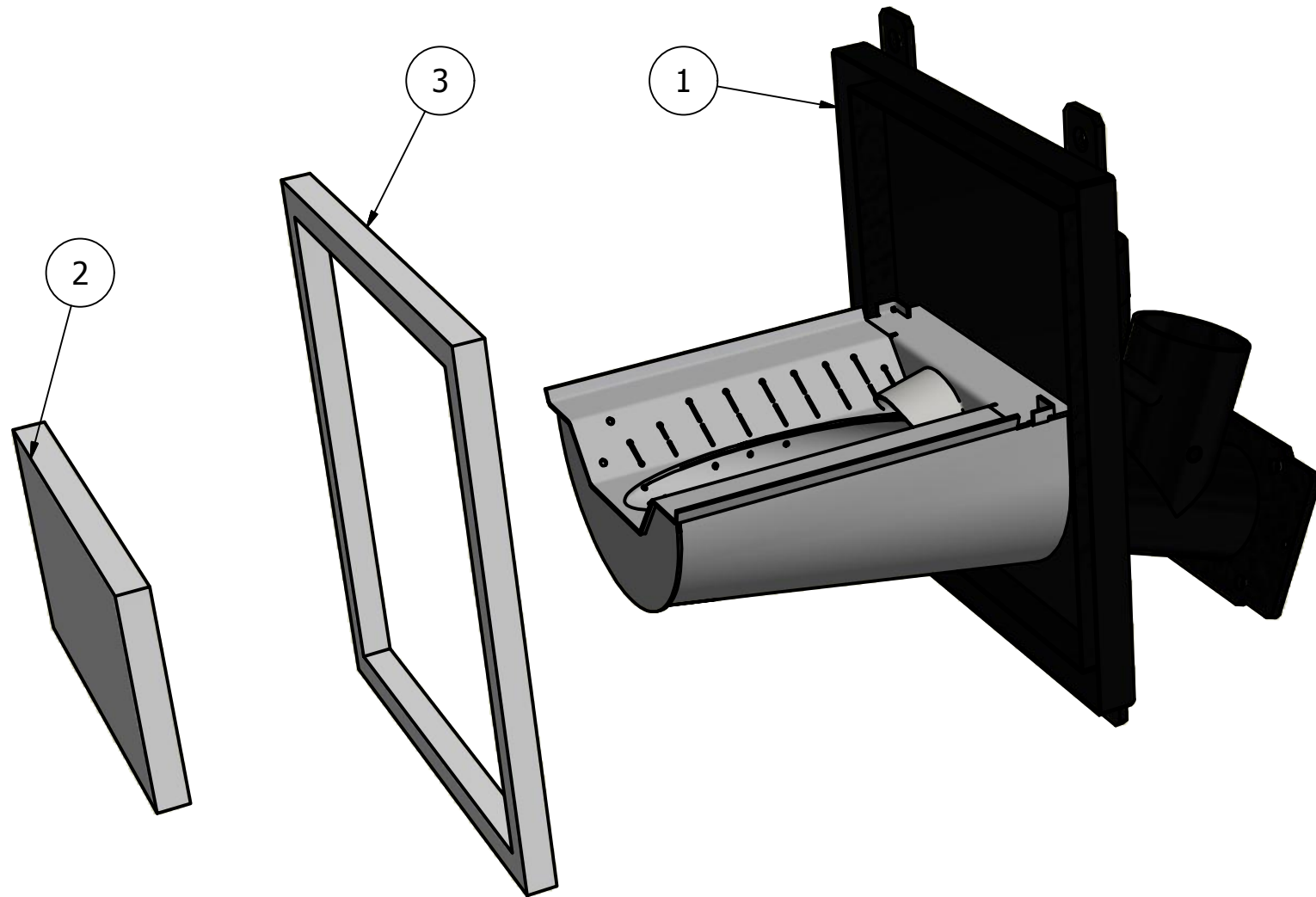

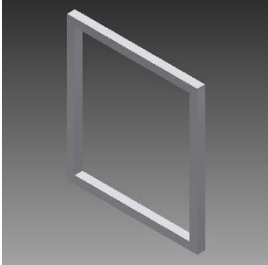
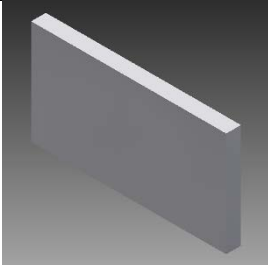

Hořák KP 10 svař+těs+sib

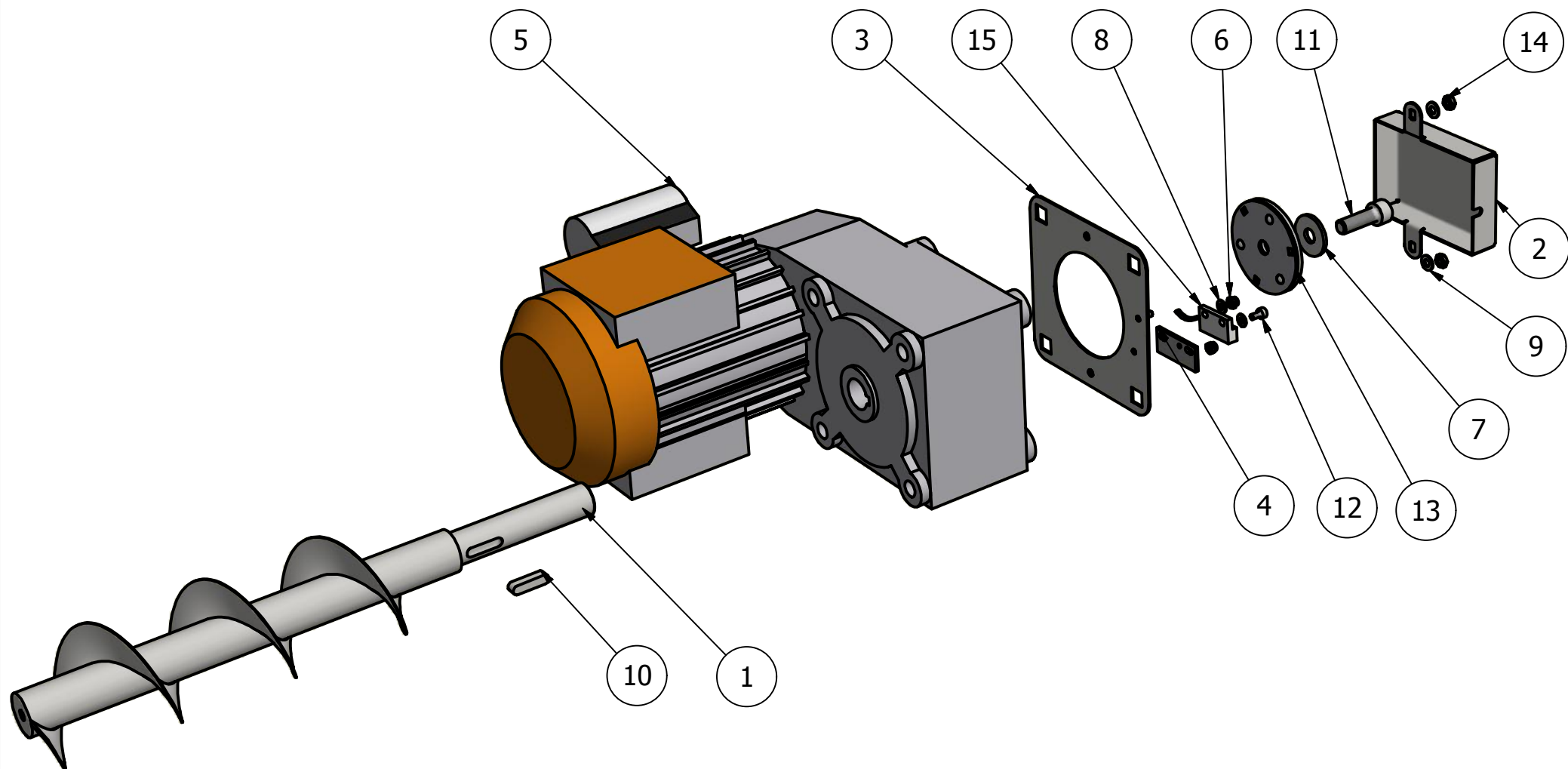

Hořák KP 10 svař+těs+sib	POZICE	POPIS	KÓD	ČÍSLO SOUČÁSTI	POZICE KS	POZNÁMKY
	1	Hořák KP 10 - svařenec	PHXX1001	099.S00.001.A3	1	
	3	ŠŇŮRA TĚSNÍCÍ 18x18-1260 DS 000	MRUZ0133		1	
	2	DESKA 20x260x14 2	MTIZ0003		1	

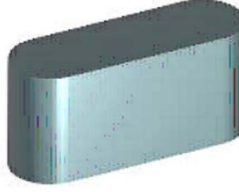
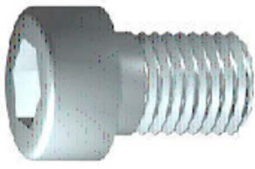
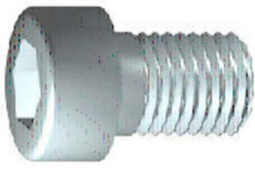

Podavač P2 TRANS_MK04+CAN.

Podavač P2 TRANS_MK04+CAN.	POZICE	POPIS	KÓD	ČÍSLO SOUČÁSTI	POZICE KS	POZNÁMKY
	1	Šnek ABM	PHXX0017	431.000.000.A3	1	
	2	KRABÍČKA SNÍMAČE SIGMATEK	MHVH0115	786.000.000.A4	1	
	3	DRŽÁK SNÍMAČE OTÁČEK	MHVH0119	428.100.000.A4	1	
	4	Adaptér pro MK04	PHXX0214	798.110.001.A4	1	
	5	Motor FT105 U88,9/40W	MEMP0040		1	
	6	Šestihřanná matice pojistná - M3	MSMX0024	DIN 985	2	

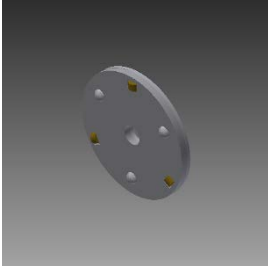
Podavač P2 TRANS_MK04+CAN.	POZICE	POPIS	KÓD	ČÍSLO SOUČÁSTI	POZICE KS	POZNÁMKY
	7	Podložka - 8,4	MSPX0008	DIN 9021	1	
	8	Podložky - B 3,2 - B 3,2	MSPX0031	CSN 02 1702	2	
	9	Podložky pro šestihranné šrouby a matice - B 4,3	MSPX0014	CSN 02 1702	2	
	10	Těsné pero 5e7 x 5 x 20	MSRX0005	DIN 6885	1	
	11	Šroub s válcovou hlavou - M8 x 25	MSSX0095	DIN 912	1	
	12	Šroub s válcovou hlavou - M3 x 6	MSSX0226	DIN 912	1	

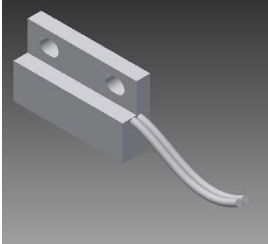
Podavač P2 TRANS_MK04+CAN.	POZICE	POPIS	KÓD	ČÍSLO SOUČÁSTI	POZICE KS	POZNÁMKY
	13	KOLO SNÍMAČE MEDER MK04/EPO	PHXX0213	PHXX0213	1	
	14	Šestihřann é matice - M4	MSSX0012	ISO 4032	2	
	15	Snímač MEDER MK04 - CANON 9	PKEX0059	Snímač MEDER MK04-CANON 9	1	

ELEKTRO

KÓD	POPIS	MNOŽSTVÍ
MERX0007	Relé VS 116K	1,0 ks
MERX0008	Mústek SP15/Z propojovací	1,0 ks
MERX0010	Pásek vázací 200/2.5	5,0 ks
MERX0013	Relé VS 308K	1,0 ks
MERX0032	Pásek vázací 100/2,5	4,0 ks
MERX0067	Přichytka PKB-BS 27x27mm přírodní samolepící	1,0 ks
MERX0078	Štítek uzemění malý /baleno po 40 ks/	5,0 ks
MERX0220	Lišta TS 35/010	1,0 ks
MERX0223	Páska Izol. 15Mm/10Mpvc bílá	2,0 ks
MERX0645	Svorka PAKL 140 přístr. pr. 1- 4mm	0,2 ks
METR0077	Procesor pro RKP-CPU	1,0 ks
METR0082	Kabel prop. K-PFL-Aud.10	1,0 ks
METR0086	Snímač tepl. TG8-40 KTY 81-220, 0,75m voda	1,0 ks
METR0091	Kabel prop K-PFL20-1500	1,0 ks
METR0094	Vidlice kabel. NAC41S.B černá ENSTO	1,0 ks
METR0103	Vidlice kabel. NBC31S.S modrá ENSTO	2,0 ks
METR0105	Vidlice kabel. NCC31S.P červená ENSTO	1,0 ks
METR0210	Zdroj RKP-PWR Revize R02.1	1,0 ks
MHVR0075	Deska základová Matušík (laser+sloupky)	1,0 ks
MREZ0012	Etiketa stříbrná 210x297 baleno po 20 ks	1,0 ks
MRUZ0021	Štítek logo PONAŠT	1,0 ks
MRUZ0151	Samolepka KP11	1,0 ks
MRUZ0219	Průchodka 24,9 x 1,6 Moss 11214	1,0 ks
MRUZ0272	Zátka antivibrační 1/2 BSP - velikost 8	1,0 ks
MRUZ0274	Zátka souběžná 46.1MM č.465668	2,0 ks
MRUZ0275	Fólie laminovací A4	1,0 ks
MTBX0033	Páska oboustranně lepící š.=15mm	0,25 ks
PKED0033	Kabeláž 11_21_51_2013 PRAVÝ kotel RKP	1,0 ks
PKED0034	Kabely P1,P2,Ventilátor KP 11.21_2013	1,0 ks
PKEX0029	Lišta vkladací 40x40x380 KP 11,21,51	1,0 ks
PKEX0042	Kabeláž zemnicí KP 11	1,0 ks
PKRX0102	Záslepka DIN konektoru	1,0 ks

PONAST spol. s r.o
Na Potůčkách 163
757 01 Valašské Meziříčí

ČESKÁ REPUBLIKA

www.ponast.cz

tel.: 571 688 111*, 800 700 068

e-mail: servis@ponast.cz